

**ON-WAFER MEASUREMENTS  
WITH THE  
HP 8510 NETWORK ANALYZER  
AND  
CASCADE MICROTECH WAFER PROBES**

**Eric Strid  
President and C.E.O.  
Cascade Microtech, Inc.  
P.O. Box 2015  
Beaverton, Oregon 97075**

**RF & Microwave  
Measurement  
Symposium  
and  
Exhibition**

 **HEWLETT  
PACKARD**

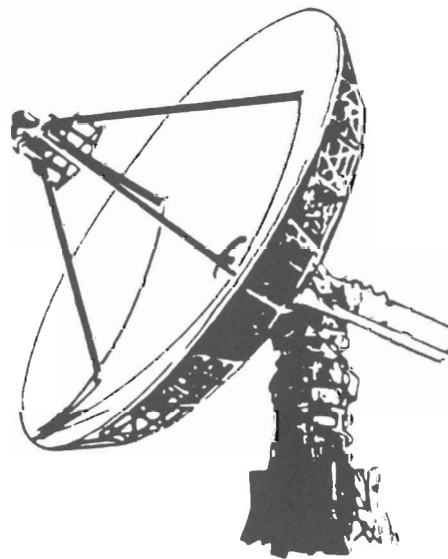

Hewlett-Packard is pleased to have the opportunity to present this paper, written by Eric Strid of Cascade Microtech, Inc., at the RF & Microwave Measurement Symposium and Exhibition.

#### Abstract:

This paper presents a system, consisting of the HP 8510 network analyzer and Cascade Microtech wafer probes, that is used to make RF measurements of microwave devices and IC's (MMIC's) directly on-wafer. The configuration of the system and the characteristics of the wafer probes are described. Techniques for making the best possible on-wafer measurements will also be addressed, and a range of on-wafer measurement applications will be examined.

#### Biography

Eric Strid received his BSEE degree at MIT in 1974 and MSEE degree from UC Berkeley in 1975. He first worked on microwave MIC's at Farinon Transmission Systems, San Carlos, CA. In 1979, he joined the gallium arsenide research group at Tektronix, which has recently evolved into TriQuint Semiconductor. In 1983, he co-founded Cascade Microtech, Inc., where he is now President and CEO. Eric has published various papers on power GaAs FET's, noise figure measurements, analog and digital GaAs IC's, and high-frequency wafer probing.

## ON-WAFER MEASUREMENTS WITH THE HP 8510 NETWORK ANALYZER AND CASCADE MICROTECH WAFER PROBES

5315

### OUTLINE

- I. Introduction
- II. The Wafer Probe System
- III. Measurement Considerations
- IV. Typical Measurements and Applications

5316

### WHY PROBE AT MICROWAVE FREQUENCIES?

- Immediate Measurements on Just Completed Wafers Without Dice and Bond
- Wafer Mapping of RF Parameters
- Practical Means to Gather a Statistically Significant Quantity of RF Data
- Further Wafer Processing After Microwave Measurements
- Automated, Active, On-Wafer Trimming

5317

In this talk, we'll be covering the basics and some details of how to use the Cascade Microtech Wafer Probe System with HP 8510 Vector Network Analyzer.

We'll start with an introduction of the problem of wafer probing at very high frequencies and a discussion of the requirements of a probe for microwave frequencies. Then we'll talk about the mechanical and electrical aspects of the Cascade probe system and how it is calibrated at the probe tips. We'll then move to error corrected measurements using a Vector Network Analyzer and some of the error considerations therein. Finally, some typical measurements and applications will be discussed.

There are a variety of uses for wafer probes at microwave frequencies. One of the obvious applications is that you can get immediate measurements on wafers that have just been completed without having to thin them, dice them out, and bond them into fixtures. It also keeps the positional information between the die intact so that you can do a wafer map of RF parameters and use this data to work on process yield improvement. Because you can automate data-taking with an autoprober, it's a way to gather a significant quantity of RF data. Finally, it's a way to do in-process microwave measurements. For example, a FET can be measured as soon as its gate metal is down, before doing passive element lithography on the wafer. We haven't seen any practical wafer trimming approaches yet, but the probes can provide a means of doing the RF measurements if you had an automated trimming solution.

## TYPICAL RF PROBE USAGE IN IC DEVELOPMENT

### Prototype Testing

- Manual RF Probe

### Test Development

- Full RF Autoprobe

### Manufacturing Test

- Sample Monitor Structures at RF
- Sample RF Testing of Component
- Full RF Testing/Binning of Component

5318

When a high speed IC or MMIC is under development, the designer can get feedback as soon as prototype wafers come out by using RF testing at the wafer level. This can be useful when there are several designs on the wafer and some designers want it diced up for RF measurements and other designers don't. When the IC is in the test development phase, there is often a lot of data taken with an autoprober and a very complete RF test plan. The key parameters that really sort between good and bad parts can be figured out, for purposes of streamlining the manufacturing test. You'll either know that if the test FETS are good at RF, the die will be good, or maybe you'll want to sample some of the components for RF testing then do a DC sort for that wafer. Or perhaps you should just do a full RF test of all parts, possibly binning components as well.

## TYPICAL RF PROBE USAGE IN HIGH SPEED DEVICE PROCESS DEVELOPMENT

### Research

- Quick Turn Around on Test of Transistors and Demonstration Devices

### Development

- Element Characterization
- Statistical Data Base for the Process
- Establish Design Limits

### Manufacturing

- Process Monitoring

5319

In high speed device process development, a quick-turnaround capability to test parts immediately after wafers come out of the fabrication lab can provide feedback at all phases. In the research environment, more experiments can be performed per unit time. As the process gets more mature, designers are interested in passive and active element characterization and then developing a large data base of the averages and standard deviations of the element's parameters and to develop design limits for the parameters. In manufacturing, the typical usage is to monitor active elements for their RF characteristics.

## PROBLEMS WITH CONVENTIONAL PROBING TECHNIQUES AT MICROWAVE FREQUENCIES

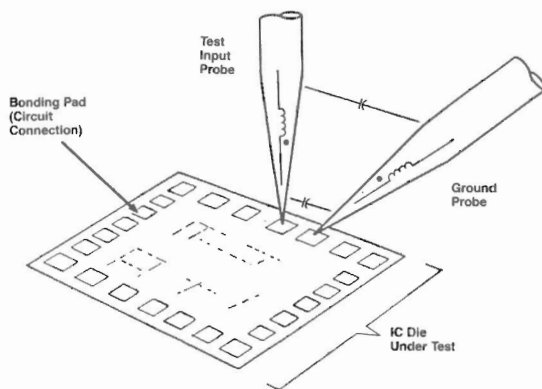

5320

At low frequencies, the basic approach to wafer probing is to use carefully aligned sharp needles to touch each pad on the IC under test. These present some basic problems at microwave frequencies because there is significant self-inductance, mutual-inductance, and mutual-capacitances between the needles and between the needles and the wafer itself. Result is that, electromagnetically, the fields are all talking to each other from probe to probe at high frequencies. If you were to look at a needle probe on a network analyzer, it would typically have a terrible return loss, look like an antenna, and have non-repeatable S-parameters at microwave frequencies.



## PROBE EQUIVALENT CIRCUIT

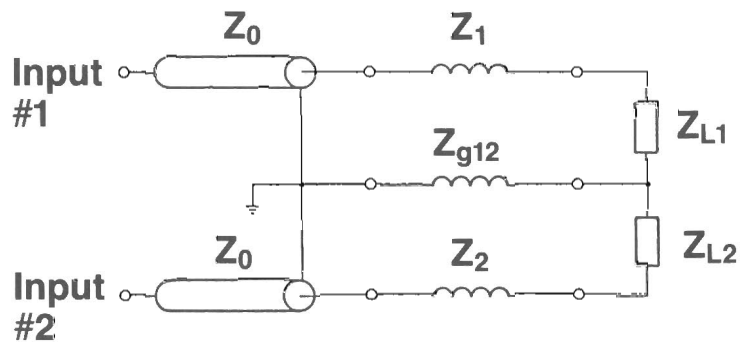

5321

This is a simple first order equivalent circuit for a few probes. We assume that there is a 50 ohm line connecting to two of these probes and a common ground connection which is connected through a ground lead  $Z_{G12}$ . There is some inductance  $Z_1$  and  $Z_2$  in the signal probes themselves before contacting the device on

the wafer ( $Z_{L1}$  and  $Z_{L2}$  here). We show the first order parasitics as inductors because usually the first problem we run into is inductance of the probes instead of the capacitances. Usually the common lead inductances,  $Z_{G12}$  in this case, are more problematic than self-inductances  $Z_1$  and  $Z_2$ .

## CROSSTALK DUE TO COMMON LEAD INDUCTANCE

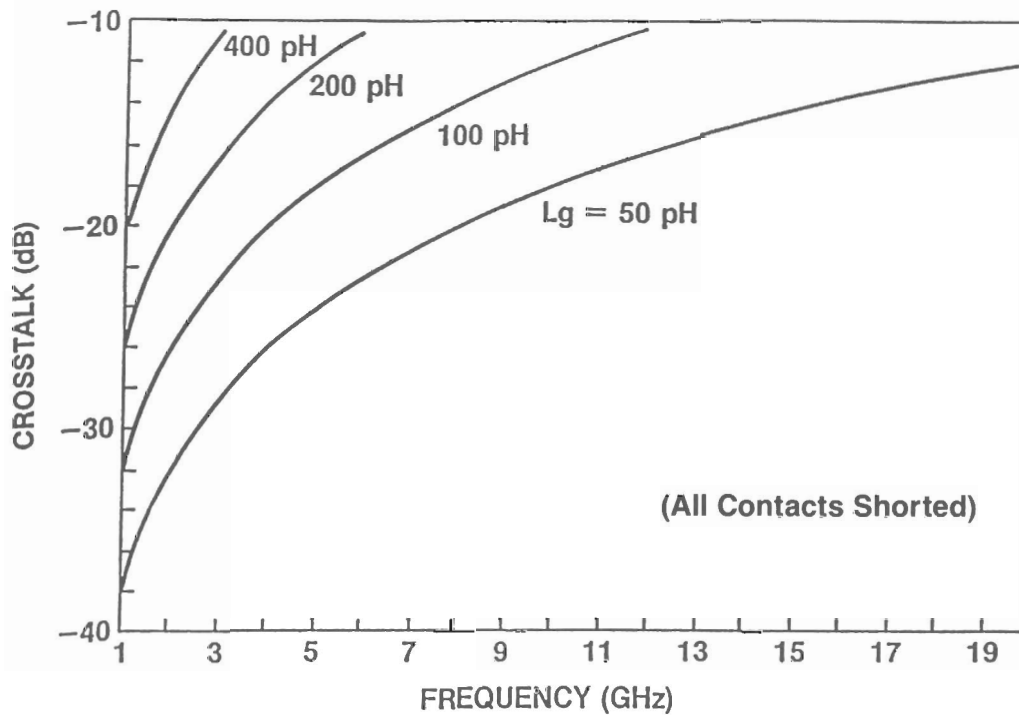

5322

This is the calculated worst-case crosstalk from the circuit of the previous slide wherein all the probe tips are shorted together. A common lead inductance of only 50 pH provides about 12 dB of isolation at 20 GHz. Since a typical bond wire has several hundred pH, this is a very significant problem when compared to small needle probes.

## ELECTRICAL REQUIREMENTS FOR MICROWAVE PROBES

- Good Return Loss (Better Than 10dB)
- Low Insertion Loss (<0.2dB)
- Repeatable Probe S-parameters (<0.01 Vector on Smith Chart), Implies Low Radiation

5323

The requirements for a microwave wafer probe are first that it have reasonably low reflections. If there is a return loss of better than 10 dB, typically a corrected vector network analyzer can then read through these reflections and get pretty clean data. Secondly, it should have reasonably low insertion loss so that the network analyzer doesn't have to correct through a large loss between it and the probe tips. Thirdly, the probe's S-Parameters should be very repeatable. When you do an error correction on the 8510, you are assuming that the S-parameters between the analyzer and the device under test are stable. We measure the repeatability by looking at the vector difference on a Smith Chart which would be typically less than .01.

## THE WAFER PROBE SYSTEM

- Mechanical Aspects
- The Probe Head
- Measurement System and Calibration

5324

Next, we'll introduce the Cascade Microtech probe system. We'll first talk about some mechanical aspects and how the probe heads are used in contacting the wafer, and then a basic approach in calibrating the Network Analyzer for measurements.

## CASCADE MODEL 42 PROBE STATION

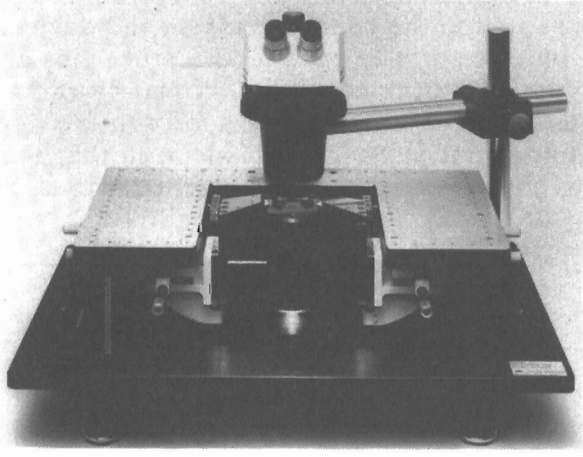

5325

Here is a photo of a Model 42 manual probe station. Its capabilities are a superset of a typical DC probe station in that DC probe needles can be mounted on the top plate, but RF probe heads can also be added on up to four sides of the device under test. All of the probes can then be raised and lowered in mass and the wafer moved underneath them manually. A key feature of this probe station is that the probe heads are held very rigidly in place so that cable forces from coaxial cables connected to the probe heads do not move the probe heads significantly with respect to the wafer. Available, but not shown here, are similar mounts for these probe heads for a Rucker & Kolls 1032 Autoprober or Electroglass 1034 or 2001 Autoprober. Also available are probe cards which mount in standard 4 1/2" wide probe card mounts on any manual or autoprober station.

### MICROWAVE PROBE HEAD

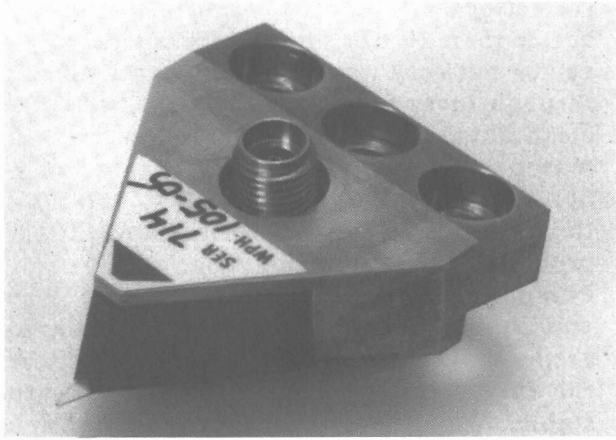

5326

This is a photo of a single line microwave probe head. This head can be considered to be an adapter from coax to device bond pads. This shows the coaxial connector and the probe tip where contact to the chip or device on wafer is made. This head is mounted on the probe station with screws through the back three holes.

### WAFER PROBE (TOP VIEW)

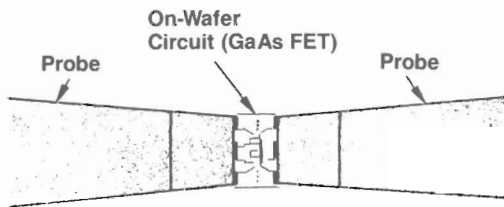

5327

This diagram is approximately what you see through the microscope when two probes are contacting an FET. In this, and the next two slides, each probe head has a ground-signal-ground contact configuration. In this view, the contacts are visible just beyond the edge of the body of the probe tip. Each probe contacts the source connection on either end of the FET with its grounds. The gate contacted on one side and the drain on the other side with 50 ohm signal lines from each probe.

### WAFER PROBE (SIDE VIEW)

3.2 Grams Per Mil

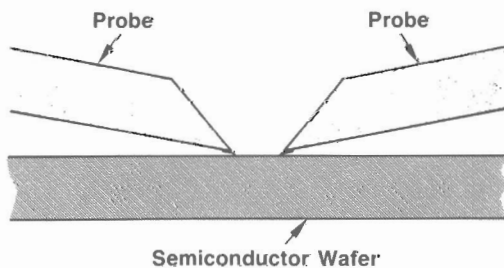

5328

The probe heads are built from 10 mil alumina and skate when contacting so that they wipe the contact pads on the device under test. The ends of the probe tips are carefully beveled in approximately this shape. The probe heads approach the device under test at about a 1:5 slope so that if the probe is vertically overtravelled 5 mils, it will skate across the pad about 1 mil horizontally.

### WAFER PROBE (BOTTOM VIEW)

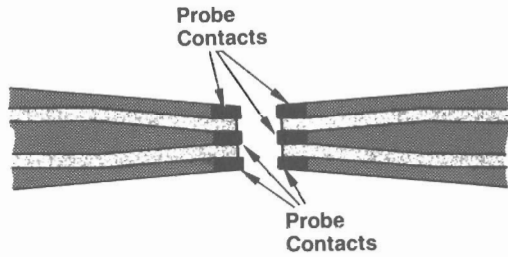

5329

This shows a view if the probes were turned over or as if we're looking at a probe tip area from the die. We see the basically coplanar waveguide approaching the probe tip and the probe contact metal plated onto the coplanar waveguide metal at the probe tips. Center-to-center spacings of the contacts are fixed, and are available from 2 mils to greater-than 10 mils.

### MEASUREMENT SYSTEM BLOCK DIAGRAM

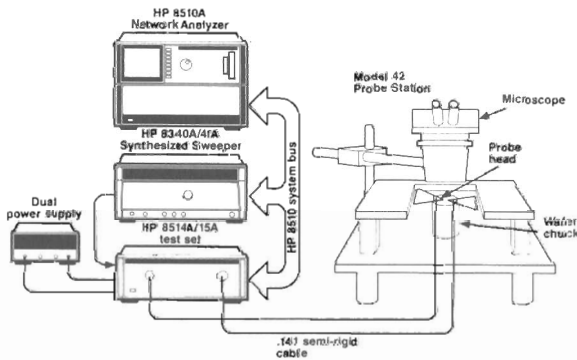

5330

A typical setup for network analyzer measurements at the probe tips simply hooks the 8514 or 8515 test set through a good cable to the probe heads. Cables need to be low reflection and good repeatability. Typically, .141" semi-rigid coaxial cable is appropriate since the probe heads move relatively little in any test. The bias for FET's or other active devices can be supplied through the bias tees in the test set. Normal connections between the 8510 and sweeper or synthesizer are used.

## BASIC ON-WAFER CALIBRATION

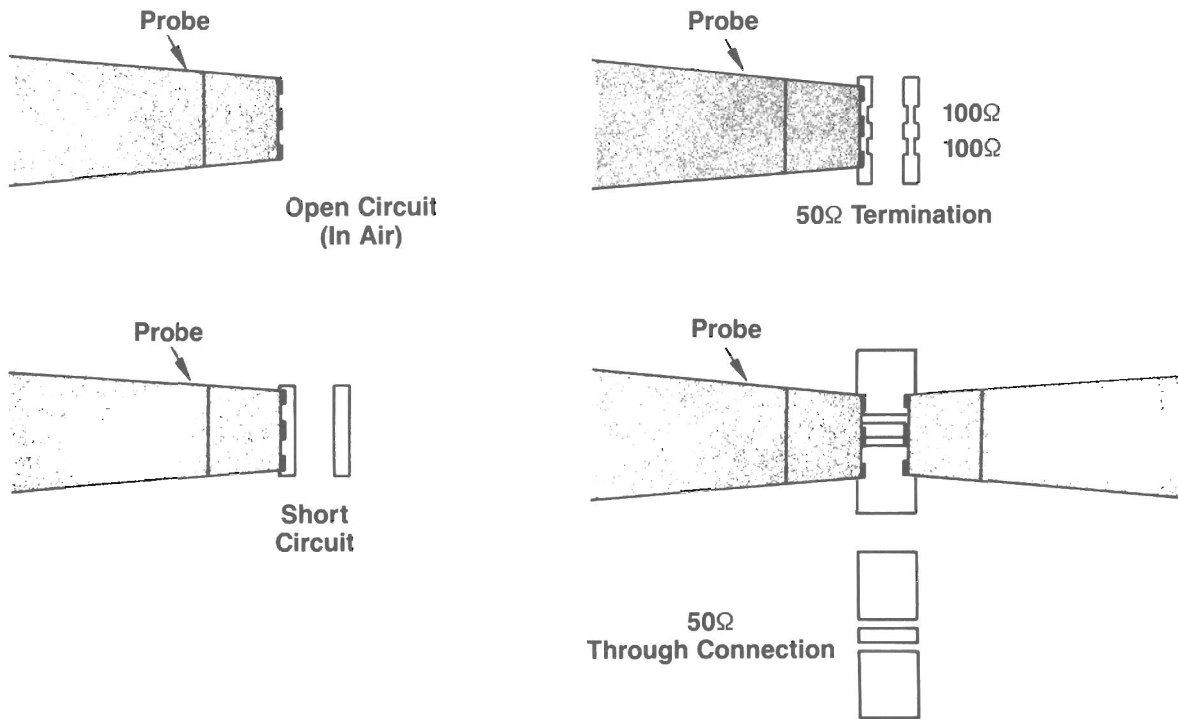

5331

This is a basic reflection calibration for a ground-signal-ground probe head. The open circuit standard is probe lifted in air. The short circuit standard shorts the three contacts on a small bar of conductor, usually a gold metalization. The 50-ohm load for a ground-signal-ground probe uses a pair of trimmed 100 ohm resistors that are about 2 mils long making a minimum sized 50-ohm load.

The typical through calibration uses a very short 50-ohm coplanar wave-guide through connection, shown with and without probes contacting it in this figure. The length of the through line (about 6 mils/ps) is entered into the cal kit for the 8510.

### IMPEDANCE STANDARD SUBSTRATE (ISS)

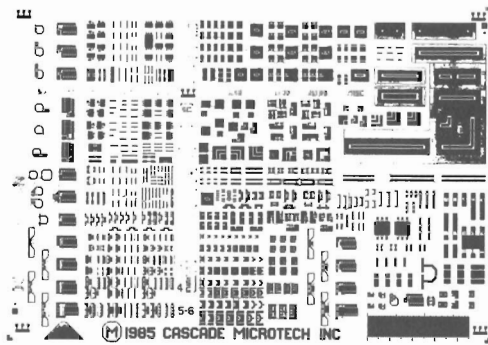

5332

A standard accessory supplied with Cascade probe stations and probe cards is an impedance standard substrate, ISS, which is used for calibrating and verifying calibrations at the probe tips. Each row in the pattern corresponds to a probe contact configuration. For example, the top row is for signal-ground probes. On the third row are a ground-signal-ground calibration and so forth. Each column refers to a different type of standard. On the first column are inductors for various probe types, then capacitors, various resistor values, then the short 50-ohm and through calibration standards, then verification patterns for two-port measurements including 10 and 20 dB pads and other miscellaneous patterns, especially transmission lines.

### MEASUREMENT CONSIDERATIONS

- Effects of Incorrect Calibration Standards Definitions
- Understanding "Planar" Impedance Standards
- Verification Techniques
- Other Sources of Error

5333

We will now explore more deeply some of the accuracy considerations in the calibration at the probe tips by first looking at what are the effects of having incorrectly specified calibration standards, then relating these to the knowns and unknowns of planar impedance standards. Then we will discuss verification techniques we've found to be useful and finally other sources of errors.

### ERROR CORRECTION BASICS

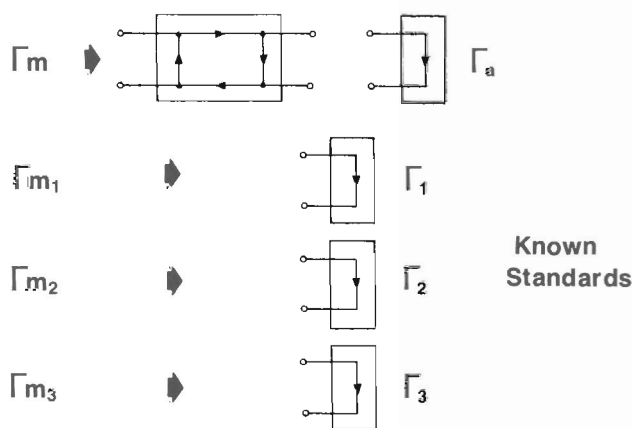

5334

The basic approach when making a one port calibration on an ANA is to assume that all the errors from the analyzer or from the cables or fixturing are described by an error adaptor. This error adaptor's parameters can be solved by placing three known impedance standards, Gamma 1, Gamma 2, and Gamma 3 at the calibration plane. For each of these, a reflection coefficient is measured, Gamma M1, Gamma M2, and Gamma M3 by the network analyzer. After the error adaptor parameters have been calculated, then the actual gammas for a device under test can be calculated from the error adaptor's parameters and the measured reflection coefficient Gamma M.

## EFFECT OF INCORRECT CALIBRATION STANDARDS

$$\Gamma_1 = 1 \text{ Open}$$

$$\Gamma_2 = -1 \text{ Short}$$

$$\Gamma_3 = 0 \text{ Load}$$

$$\Gamma_a = \frac{\Gamma_1 \Gamma_2 2\Gamma_m + \Gamma_2 \Gamma_3 (1 - \Gamma_m) + \Gamma_1 \Gamma_3 (-1 - \Gamma_m)}{\Gamma_1 (\Gamma_m - 1) + \Gamma_2 (\Gamma_m + 1) + \Gamma_3 (-2\Gamma_m)}$$

5335

Instead of simply solving for the error adaptor's S-parameters with three known standards, we keep all the unknowns in the equation, i.e. keep the three known standard impedances, Gamma 1, Gamma 2, and Gamma 3 as unknowns because we don't completely know about them. Then we postulate that we have cascaded the error adaptor with an arbitrary adaptor which has resulted in a condition of Gamma M1 (a perfect open), Gamma M2 is a perfect short, and Gamma M3 is a perfect load. Gamma actual is then given by this equation. In other words, this equation shows how imperfect standards will cause measured reflection coefficients to be incorrectly mapped by the error adaptor.

## EFFECT OF INDUCTANCE IN LOAD STANDARD

OPEN =  $1 + j0$   
SHORT =  $-1 + j0$   
TERM =  $0 + j.025$

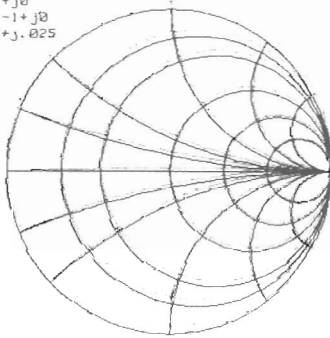

5336

In the following slides, the solid lines show a normal Smith Chart, and the dotted lines display a distorted Smith Chart, which is the locus of points which would be measured having incorrectly specified some parameter of the calibration standards. (Think of each chart as being at a single frequency). This figure shows the effect of having a perfect open and short impedance with an inductance in the termination. As we see at the top of the Smith Chart, the distortion is accentuated so that a measured high-Q inductor would be outside of the Smith Chart if it were on the edge of +j 50 ohms. At the bottom of the Smith Chart, a minus j 50 ohm impedance would be measured to have several ohms real.

## EFFECT OF INDUCTANCE IN SHORT CIRCUIT STANDARD

OPEN =  $1 + j0$   
SHORT =  $-1 + j-.05$   
TERM =  $0 + j0$

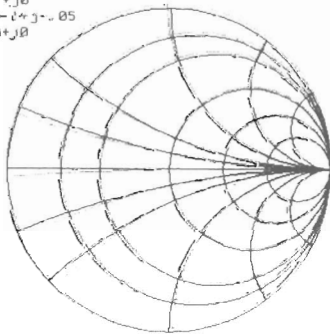

5337

This chart shows the effect of having the correct open calibration standard, a correction load standard, and the short standard having an incorrect offset. In this case, again, a high Q inductor would go outside the Smith Chart and a high Q capacitor would appear to be too resistive.



**EFFECT OF INCORRECT  $C_0$   
FOR OPEN CIRCUIT STANDARD**

OPEN= $1 + j.05$   
SHORT= $-1 + j0$   
TERM= $0 + j0$

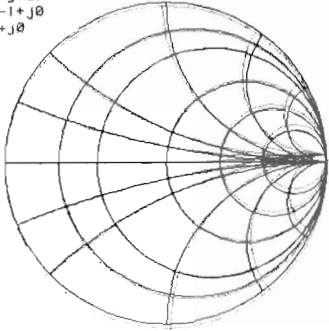

5338

This chart now refers to the short being correct, the load being correct, and the open having an incorrect offset. This causes a distortion on the top and bottom of the chart in the same fashion as the short offset on the previous slide.

**EFFECT OF OFFSETTING BOTH  
SHORT AND OPEN CIRCUIT STANDARDS**

OPEN= $1 + j.05$   
SHORT= $-1 + j-.05$   
TERM= $0 + j0$

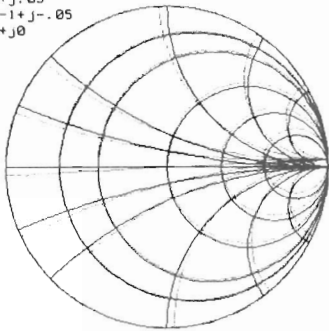

Effectively Moves the Reference Plane

5339

This figure shows the effect of having an offset on the short and an equal offset in the open. The termination is assumed to be perfect. In this case, the offsets in the open and short, as we might expect, cause a rotation of the entire chart corresponding to a movement of the reference plane. Note that this analysis is applicable to coaxial or other transmission media as well.

## SHORT CIRCUIT STANDARD REFERENCE PLANE VS. OVERLAP DISTANCE

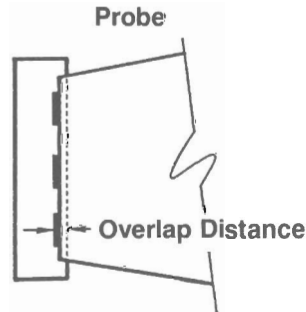
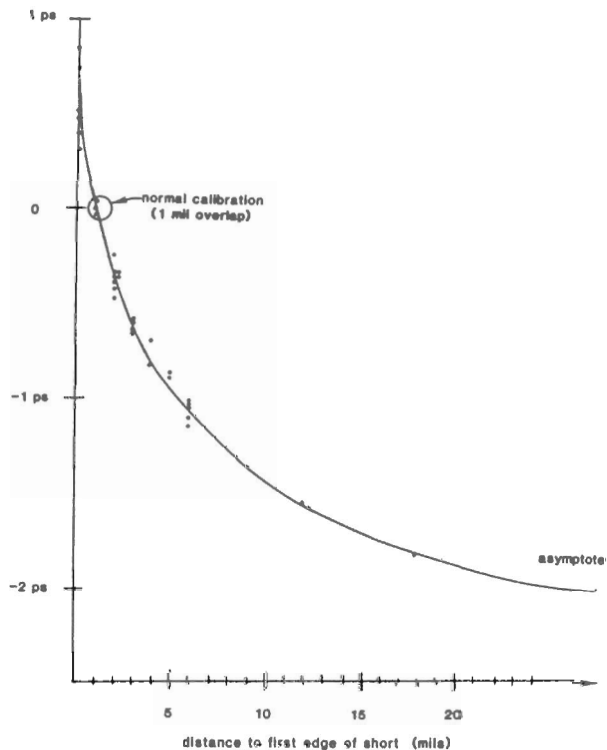

5340

One of the effects we've seen on the planar short standard is that the reference plane is not set by the physical planar contact to the short pattern, but effectively by how much the probe overlaps the edge of the short underneath the probe tip. This graph shows the relative delay versus the overlap distance of the probe head over the short metal. We recommend normally that the short standard be contacted with about a 1 mil overlap. This is done by centering the probes on a 2 mil wide short bar. This 1 mil overlap is somewhat arbitrarily chosen and could be moved to some other overlap if the offset for the open circuit, for

example, was also moved. If the probe is just contacting the short on the edge of the metal, the actual edge of the gold mashes out on the edge of the short circuit so there is a relatively large scatter at zero overlap. Note that it is possible to make repeatable measurements within a fraction of a ps if the probe is carefully placed over the short-circuit. As the probe overlaps the short more and more, an asymptote of about 2 ps of effective shortening is reached. This is where the probe is overlapping the short by 25 mils or more. There is a similar but less sensitive effect of the reactance of the 50 ohm load standard as function of where it is contacted by the probe.

## ONE-PORT VERIFICATION WITH RESISTORS

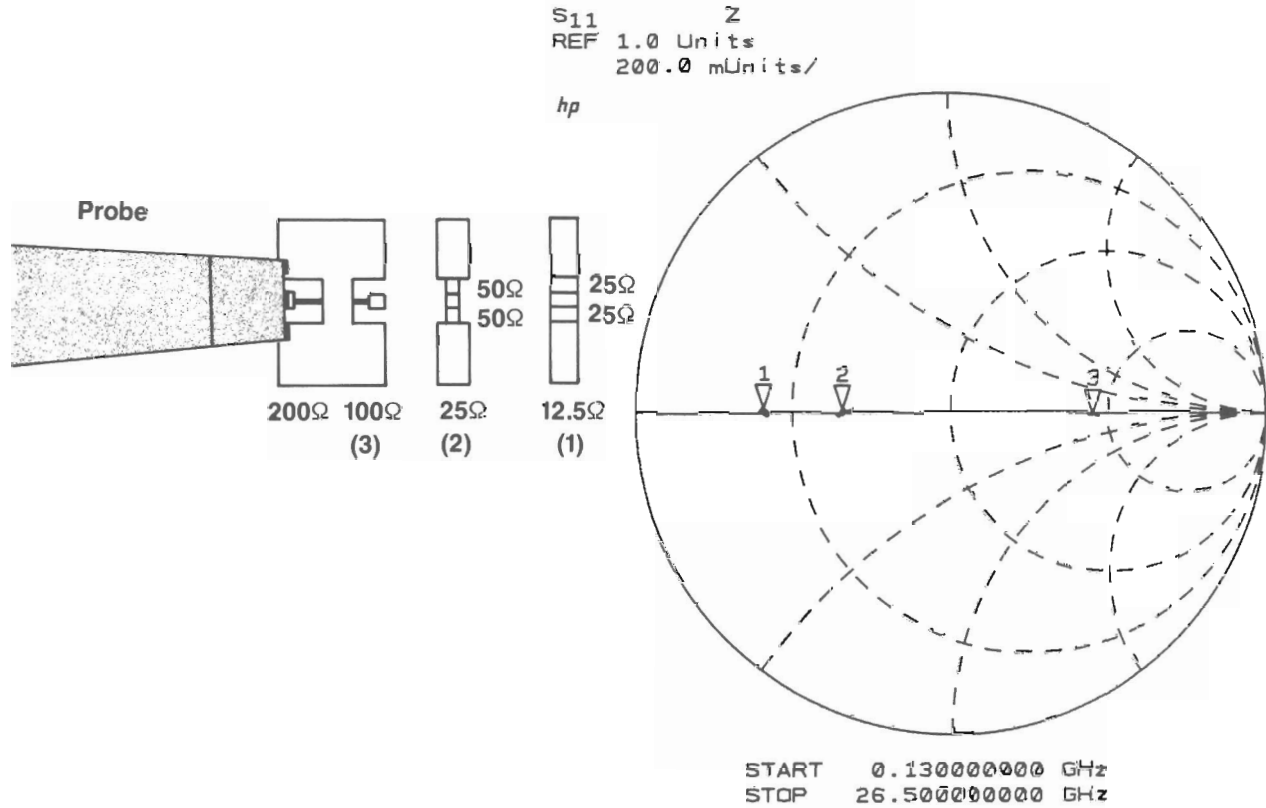

5344

For each probe configuration, there are several resistor values available on the ISS which can be used for 1 port verification standards. For example, the ground-signal-ground probe is contacting a 200 ohm resistor, a 100 ohm resistor, a 25 ohm resistor and a 12.5 ohm resistor. The results

of such measurements are shown in the Smith Chart wherein marker 1 shows the 12.5 ohm resistor measurement, 2 shows the 25 ohm resistor, and 3 shows the 100 ohm resistor. The measured reactance of each of these is a slight function of where the probe contacts the actual metalization on the resistor ends, as with the short standard.

## TWO-PORT VERIFICATION WITH ATTENUATORS

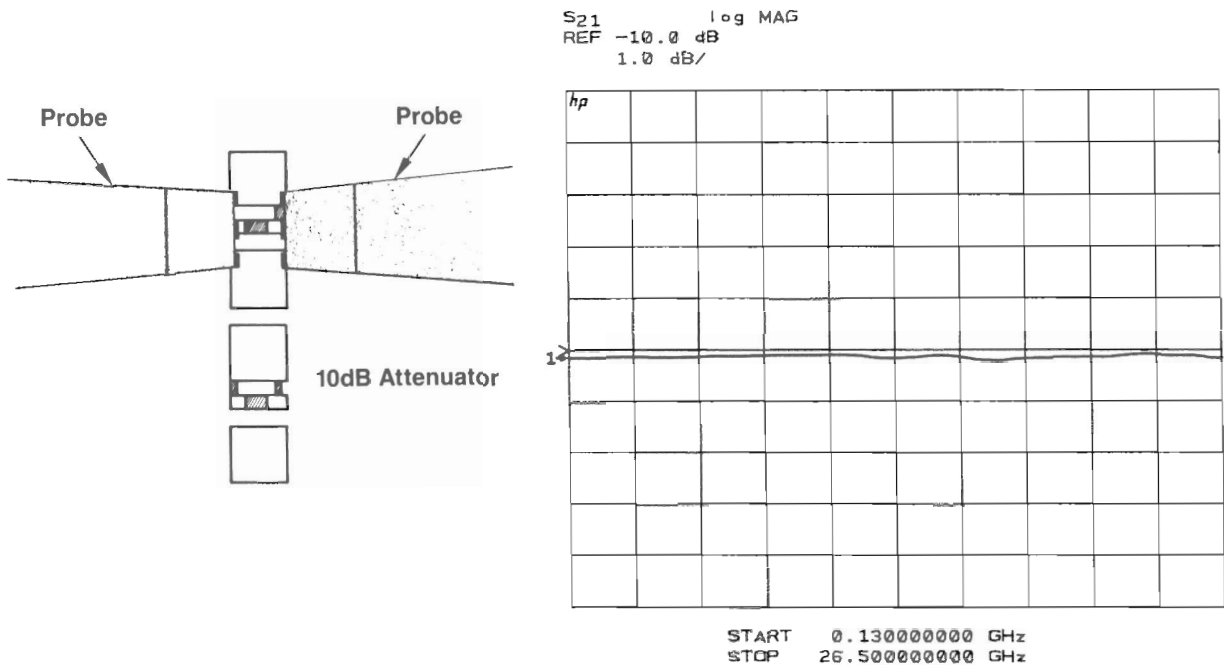

5345

This is an example of a 2-port verification standard wherein a 10 dB pi-section pad is used to make a 50 ohm load on each port and about a 10 dB attenuation from the port 1 probe to the port 2 probe. A log-magnitude plot of S<sub>21</sub> is shown to be very close to 10 dB of attenuation through 26 GHz for this verification standard.

## ONE-PORT VERIFICATION USING OPEN STUB

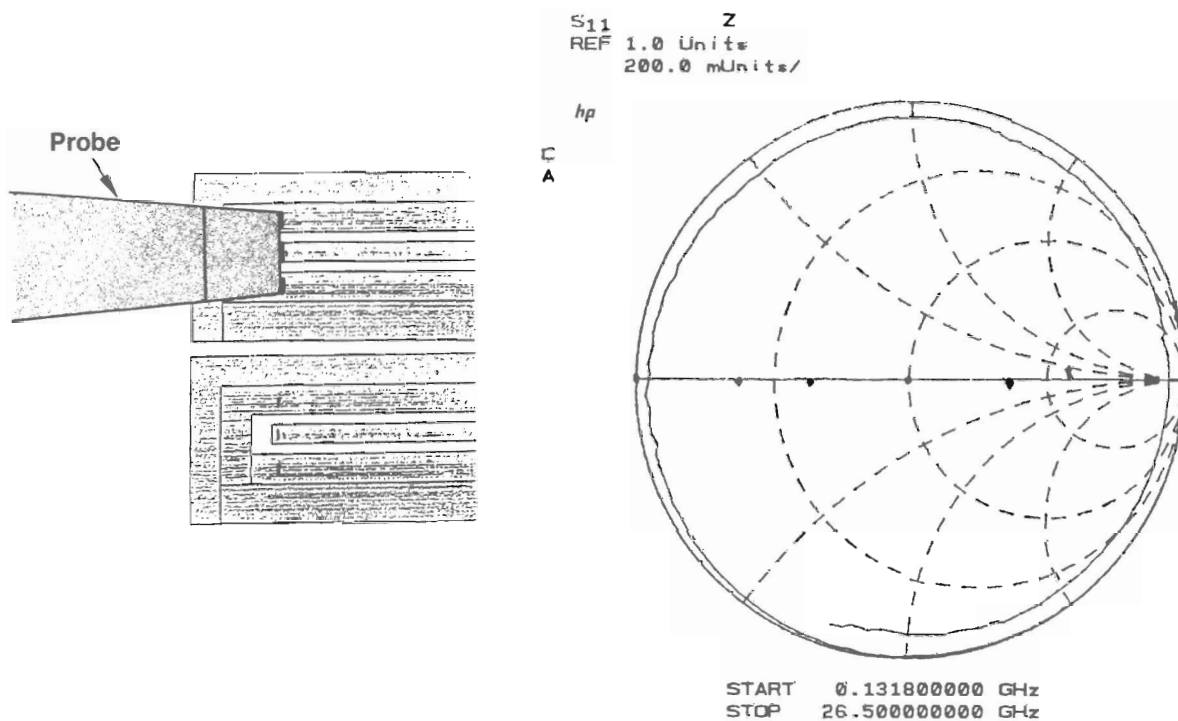

5346

The best verification standard we have found for 1-ports (especially with ground-signal-ground probes) is a small coplanar waveguide open stub. It is shown with and without a probe contacting it in this figure, with the Smith Chart of the resulting correctly calibrated reflection coefficient of the open stub. Since the lines in the coplanar waveguide are only a couple mils wide, the loss is relatively high. In this example, the length is about 120 mils or 3 millimeters. The reflection coefficient of the stub starts out at an open, goes through

a short at about 10 GHz, goes back near an open at 20 GHz, then stops at 26 GHz. We would expect that the magnitude  $S_{11}$  would decrease monotonically with frequency because the losses are increasing with frequency. This is a sensitive measure of whether the reactances of the impedance standards (the short, open, and load) have been correctly chosen for the calibration. If they were incorrect, the reflection coefficient of the open stub would be too high or low at the top or the bottom of the Smith Chart as shown in the previous distorted Smith Chart predictions.

## EFFECT OF INDUCTANCE IN LOAD AND OPEN CIRCUIT

OPEN= $1+j.1$   
SHORT= $-1+j0$   
TERM= $0+j.025$

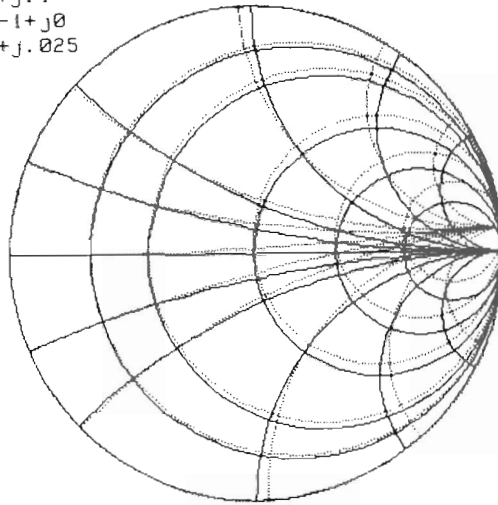

5347

The magnitude of the measured open stub reflection coefficient gives us a good insight into whether the magnitudes are being correctly measured. However, this distorted Smith Chart shows an example of an incorrect open offset as well as an inductance of the 50 ohm standard. The combined effect gives an accurate measured reflection coefficient magnitude at the top and bottom of the Smith Charts, but its phase is incorrect, especially near the open.

By minimizing the deviation from linear phase of the measured phase of the open stub, another one of the reactances of the three impedance standards can be determined. Since all three of the standards of the load, the short, and the open have, to some extent, an unknown reactance, we have three unknowns. Two then can be verified by the magnitude and the phase of the open stub verification standard, and the third one effectively just sets the reference plane of the measurement.

# LEAKAGE BETWEEN PROBES (GROUND-SIGNAL CONFIGURATION)

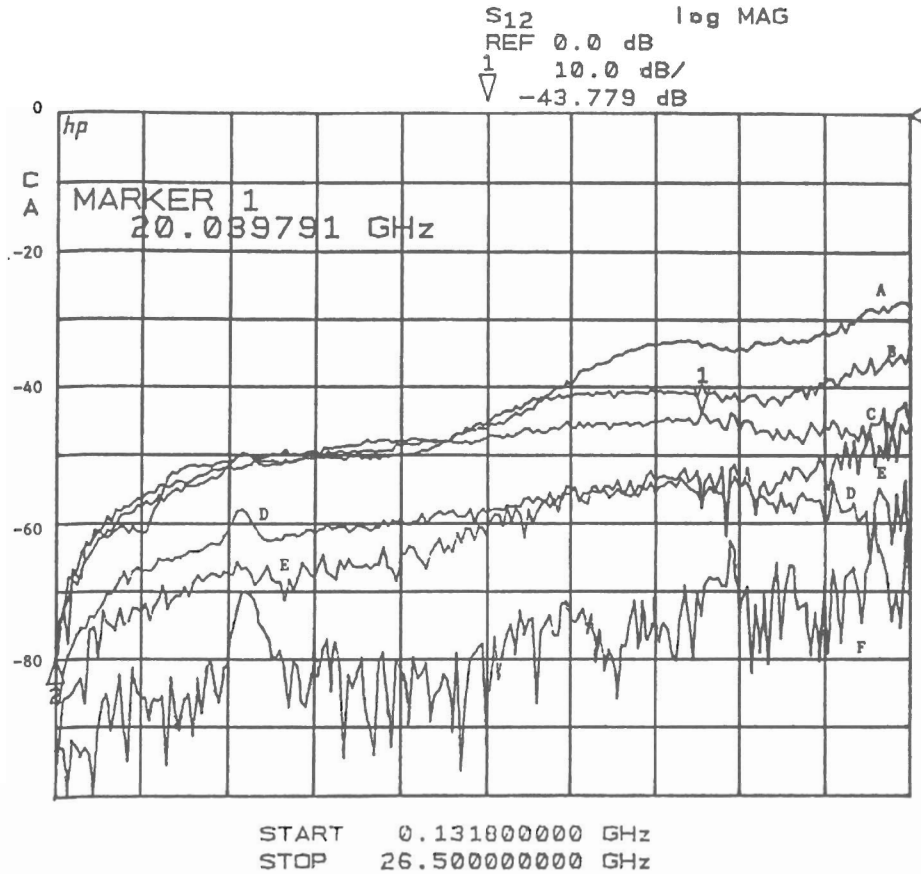

5341

Another potential source of errors in two-port measurements is crosstalk from the fixturing, i.e. probes in this case. Since the isolation error term of the normal 12-element model is only a partial isolation correction, we do not use it with wafer probes and omit the isolation (effectively zeroing out the EX error terms). This plot shows a series of different cases measured through 26 GHz between a ground-signal probe and a signal-ground probe. The top trace corresponds to the two probe heads both contacting short circuits which are separated by about 10 mils. The next trace shows two 50-ohm terminations which are also 10 mils apart. The next trace shows the

probes 10 mils apart lifted up in air. Trace D is the case where the probes are 30 mils apart in air. Trace E has the probes in 30 mils apart, but both on 50 ohm terminations. Trace F is where the probes are 100 mils apart in error. One of the interesting problems of measuring crosstalk is defining a standard for zero crosstalk. For example, you would expect there to be some mutual inductance in Trace A and mutual capacitances in the open cases, and mutual inductances and capacitances in the terminated cases. However, you would not expect to see the structure at 5 GHz from a simple coupled inductance or capacitance case.

# LEAKAGE BETWEEN PROBES (GROUND-SIGNAL-GROUND CONFIGURATION)

S12            log MAG  
REF 0.0 dB  
10.0 dB/

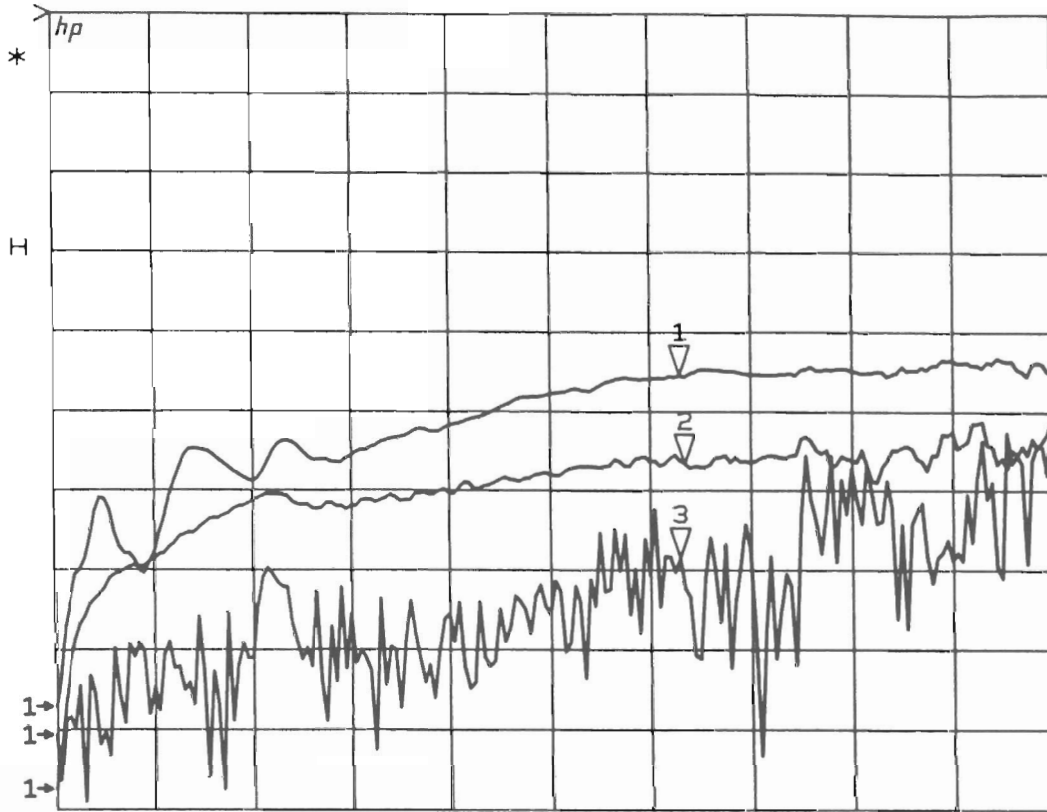

START 0.130000000 GHz  
STOP 26.500000000 GHz

5342

Some similar crosstalk measurements done for ground-signal-ground probes are shown here. The top trace shows both probes contacting short circuits but separated by only 4 mils. The second trace shows both probes in air about 8 mils apart, and the third trace shows probes in air separated by

100 mils. There is about 20 dB better crosstalk with the ground-signal-ground probe pair than with the ground-signal-ground probes from the previous figure. This apparently is due to the extra ground in the ground-signal-ground case effectively shielding the field from coupling to something else.



## TYPICAL MEASUREMENTS AND APPLICATIONS

- Diode Measurement
- Discrete FET Measurement
- MMIC Measurement
- Parameter Extraction and Database Development

5348

Some typical measurements and applications we'll show are a diode measurement, a discrete FET, an MMIC measurement, and the parameter extraction of a GaAs FET for purposes of data base development.

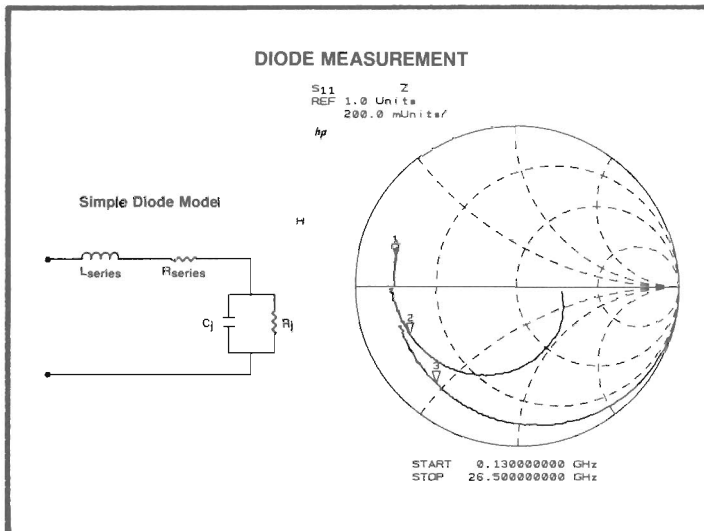

5349

This figure shows an example of a diode measurement. The device under test is actually the gate source of a GaAs MESFET with the drain open, but it is very similar for other types of schottky or pn diodes. The measured data for trace 1 is when there is one volt forward bias on the gate. We see that the device is basically about 6.8 ohms in series with an inductance of about 44 pH. It starts at low frequency at the 6.8 ohm intercept and goes inductive at higher frequency. Bias condition 2 still has some conductance in the diode where at low frequencies the resistance is about 100 ohms. The third trace on the Smith Chart shows 0 volts on the gate, which clearly corresponds to a series resistance and the gate source capacitance. This very clean measurement of S-parameters can result in convincing models using lumped equivalent circuits of the elements.

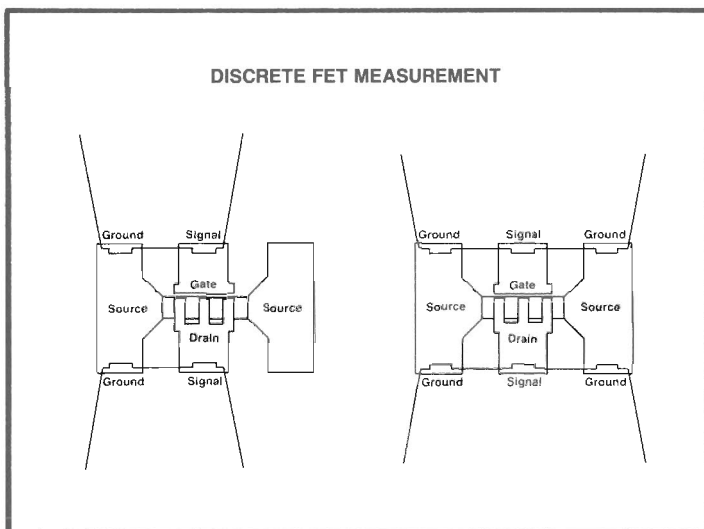

5350

We will demonstrate two examples of FET measurements. In each case, we've used the same device at the same bias condition but probed it in two different ways. First, we'll show the device measured with a ground-signal probe on the drain side and a signal-ground probe on the gate side. We'll then show a ground-signal-ground on both the gate and the drain of the FET.

# DISCRETE FET MEASUREMENT (GROUND-SIGNAL CONFIGURATION)

TEST FET GS-SG VDS=3 VGS=0 11/22/85

----- S11  
 ----- S21 RADIUS=5  
 ----- S12 RADIUS=.1  
 ----- S22

gm 37.30 mS (intr)  
 Cgs 412 fF  
 Cgd 29 fF  
 Cds 99 fF  
 Tt 5.5 pS  
 rd 520 ohms  
 Rin 4.20 ohms  
 Re 1.20 ohms  
 Rg .50 ohms  
 Ld 55 pH  
 Lg 28 pH  
 Ls 35 pH  
 gmrd 19.40  
 gm/c 12.63 GHz  
 Ft =14.77 GHz

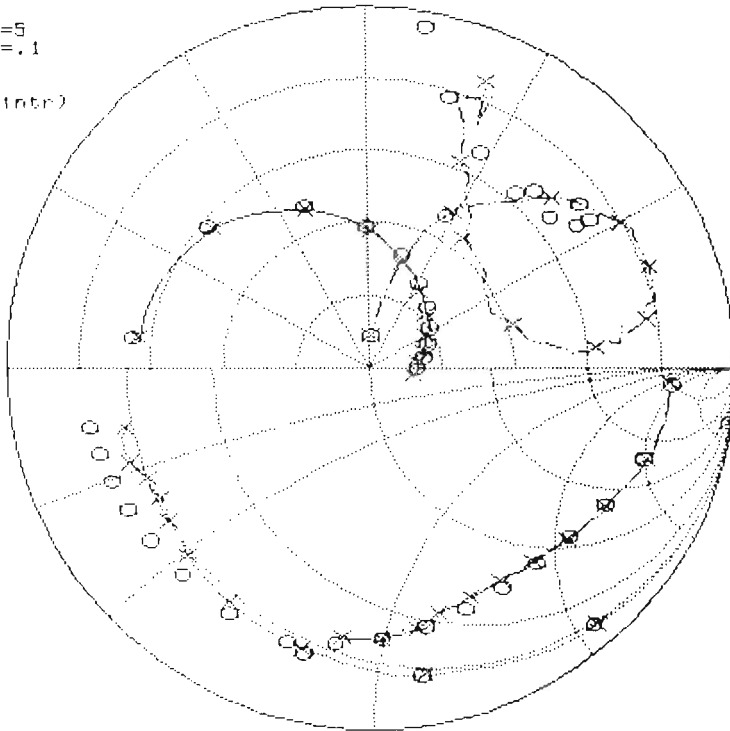

5351

When measured with the ground-signal and signal-ground probes, the S-parameters match a lumped equivalent circuit up to roughly 12 GHz, but extra parasitics are involved and the match to the simple equivalent circuit becomes inaccurate. Also, the slight bumpiness of the data at above 20 GHz is probably due to the higher crosstalk of the ground-signal probes.

# DISCRETE FET MEASUREMENT (GROUND-SIGNAL-GROUND CONFIGURATION)

TEST FET V06-3 VGS=0 11/22/85

..... S11  
 ----- S21 RADIUS=5  
 - - - - - S12 RADIUS=.2  
 ----- S22

gm 37.90 mS (intr)  
 Cgs 412 pF  
 Cgd 29 pF  
 Cds 99 pF  
 Tt 5.5 pS  
 rd 520 ohms  
 Rin 4.20 ohms  
 Rz 1.20 ohms  
 Rg .50 ohms  
 Ld 23 pH  
 Lg 20 pH  
 Ls 0 pH  
 gmrd 19.40  
 gm/c 12.63 GHz  
 Fc =14.75 GHz

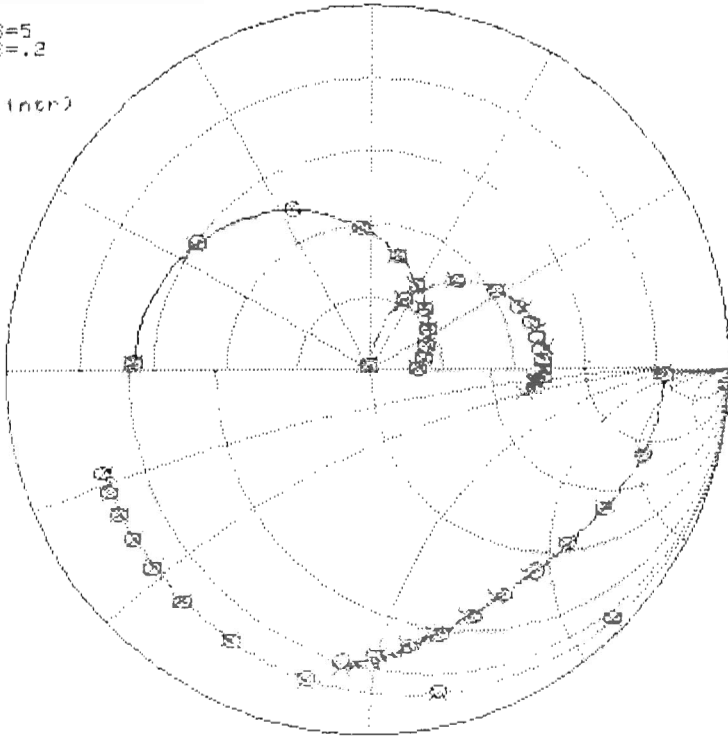

5352

When measuring the same device at the same bias condition with ground-signal-ground probes from the gate side and the drain side, notice that there is now a very good fit to a basic lumped equivalent circuit for the FET. The source inductance has been decreased drastically, and the crosstalk from one probe to another is reduced by the ground-signal-ground probes.

# MMIC MEASUREMENT

S<sub>21</sub> log MAG  
REF 0.0 dB  
2.0 dB/

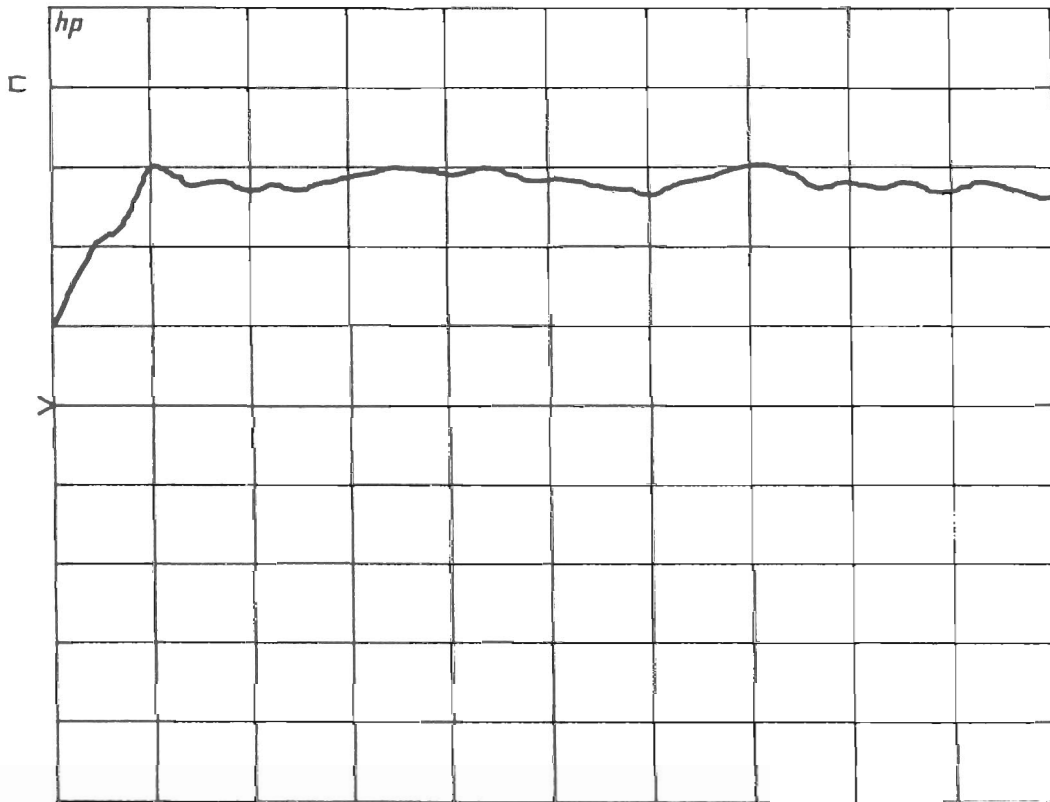

START 0.500000000 GHz  
STOP 20.000000000 GHz

5353

Here is an example of measuring a single MMIC amplifier stage from 0.5 to 20 GHz. The measurements on single stages are often cleaner than what people have been able to measure in their packages. To probe MMIC's using microstrip as the transmission media, it is necessary to bring the ground

contact from the back side up to the surface at the inputs and outputs for contacting with the coplanar probes. Usually a little bit of thought at the layout stage of a device or circuit can result in much easier and cleaner measurements later when the device is to be probed.

## EQUIVALENT CIRCUIT PARAMETER EXTRACTION

### Equivalent Circuit Model

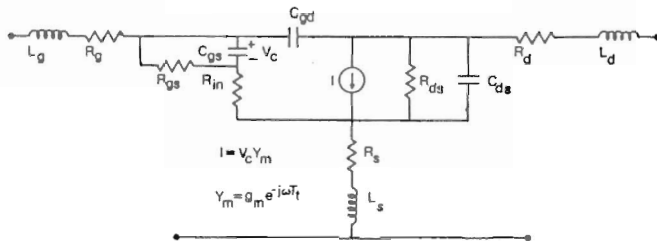

$$I = V_c Y_m$$

$$Y_m = g_m e^{-i\omega\tau}$$

TEST FET V05-3 VGS=0 11/22/85

----- S11  
 ----- S21 RADIUS=5  
 ----- S12 RADIUS=.2  
 ----- S22

gm 37.30 mS (intr)  
 Cgs 412 fF  
 Cgd 29 fF  
 Cds 99 fF  
 Tt 5.5 pS  
 rd 520 ohms  
 Rin 4.20 ohms  
 Ra 1.20 ohms  
 Rg .50 ohms  
 Ld 23 pH  
 Lg 26 pH  
 Ls 0 pH  
 gmrd 19.40  
 gm/C 12.63 GHz  
 Ft =14.75 GHz

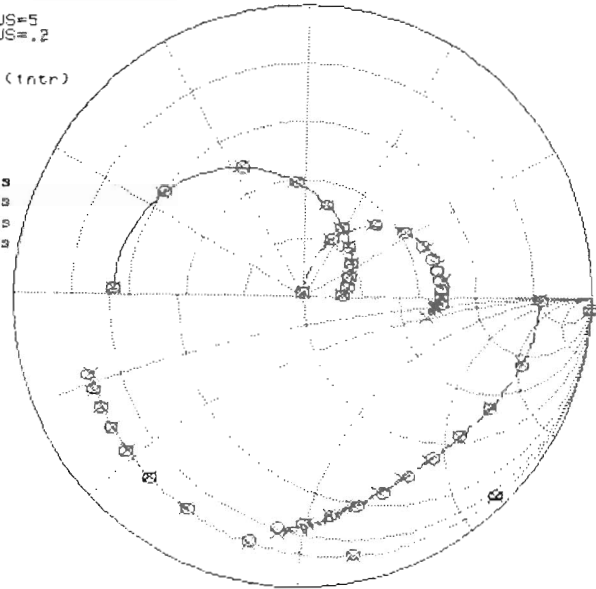

5354

The ability to manually probe and autoprobe FET elements on the wafer and very accurately extract a lumped equivalent circuit for the measured data has led many foundries to using the averages and standard deviations of the lumped elements as design limits for MMIC design instead of

the raw S-parameters. Besides decreasing the volume of data to be specified, single element variations across the wafer or variations due to temperature or variations due to bias conditions can be monitored. This type of data base also gives more direct feedback to the process engineer for yield enhancement information.

### EXAMPLE DATABASE OF RF PARAMETERS

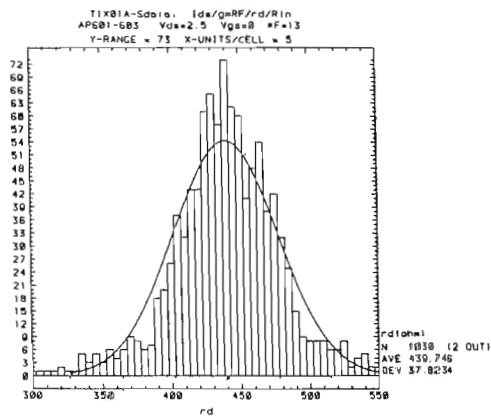

5355

### SUMMARY

5356

One of the difficulties specific to gallium arsenide design is that there is usually enough electron traps in the material that the dc parameters of a FET, especially drain conductance, are not at all similar to the device's RF parameters. The drain conductance is usually about 10 times as high at high frequencies in a GaAs FET. This histogram shows an example of the drain conductance measured over 1000 devices and fitted to an equivalent circuit from RF probed S-parameters of the transistor elements. In this fashion, the designer can easily see parameter spreads expected by a process.

In summary, we've seen that the combination of an 8510 network analyzer and Cascade wafer probes can provide a very beneficial tool for device and IC developers at prototyping, development, and manufacturing phases. We've looked at details of the calibration standards and ways to verify that the calibration is correct. We've seen that it makes a difference how devices under test are contacted, and it can save a great deal of testing and modeling effort later if the device is simply laid out optimally for testability. Finally, the capability to generate a large data base of RF parameters is revolutionizing both IC design for microwave frequencies and yield enhancement techniques for MMIC and high-speed processes.

